



**cumberland**

Granulators | Shredders

## **T50 SERIES**

Tangential Granulators

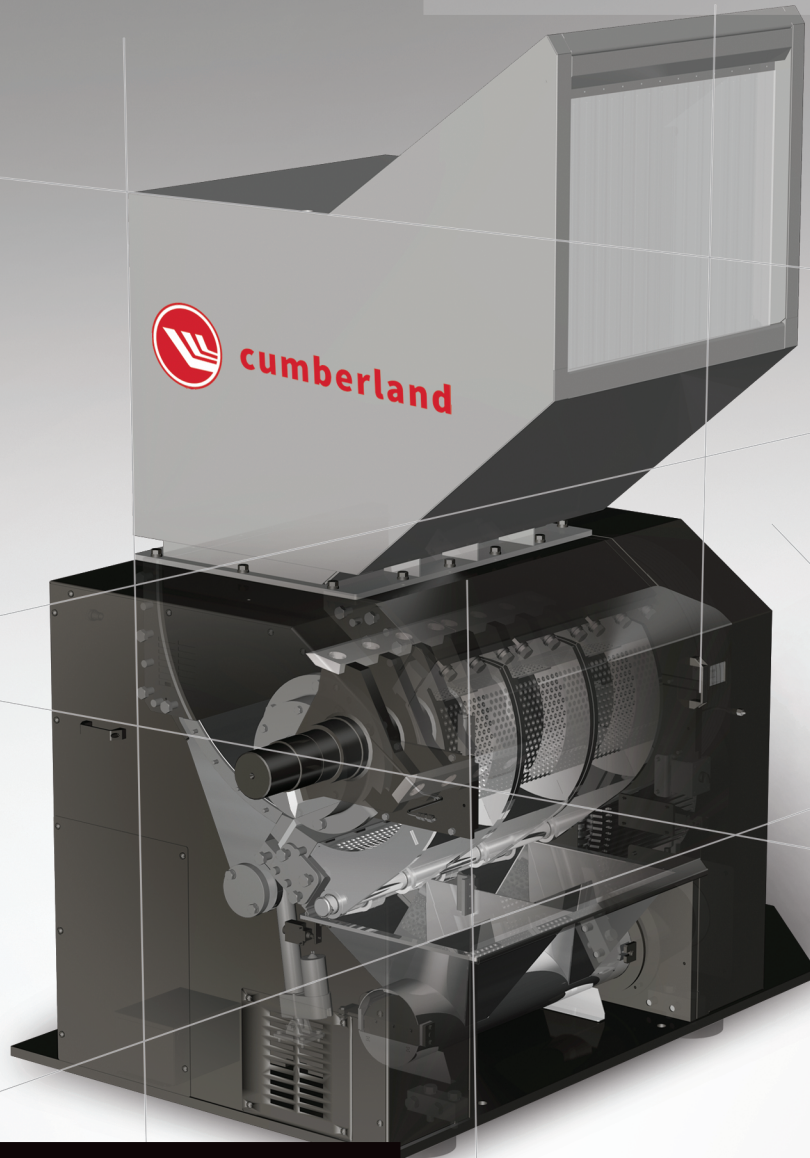

*Exceptional Regrind Quality*

*Ease of Maintenance & Safety*

*Application Flexibility*

### **Built to Last**

Flexibility to process large volume parts, with the capability to configure the cutting chamber to grind higher density parts.

[www.cumberland-plastics.com](http://www.cumberland-plastics.com)

# Tangential Granulators: Exceptional Regrind Durable Design

The precision tolerance cutting chamber creates the industry leading regrind consistency, and allows for smooth reprocessing. The high quality output makes it easier to utilize the maximum amount of recycled material in your process.



#### Variety of Infeed Options

Conveyor feeds, tray feeds, side feeds, sheet & a variety of custom options to meet your application needs



#### Regrind Evacuation & Transport

Conveyor and evacuation systems are sized for your specific application. Multiple configurations to handle your material needs



#### Sound Dampened Design

Cutting chamber and hopper suppress harmonic noise and material originated sound



#### Intelligent Control System

User intuitive color touchscreen for ease of operation. Network connectivity provides remote access to machine



#### Cutting Chamber Enhancements

Abrasion resistant packages for high wear applications. The water cooled rotor option limits heat generation



#### Variety of Screens

Reversible screens for longer-lifetime, optional heat-treatment for high wear applications. Custom screens: milled back or perforated styles available for specific customer applications

# T50 SERIES

## Granulation Solutions Tailored for Your Specific Needs

The T50 Series Granulators offer strong, versatile, and reliable performance. With a full range of size and design options to choose from, the T50 Series Granulator are the best choice for applications ranging from large injection or blow molded scrap, furniture components and appliance parts. The tangential design offers the capacity to process many types of scrap with improved ingestion at a lower power requirement, while the offset design allows for higher throughput of lower density parts. Energy efficiency paired with heavy-duty design and ease-of-maintenance results in a granulation system with a low total cost of ownership.



### Industry Leading Aftermarket Support Available

#### Technical Support & Training

Cumberland provides expert technical support and training, allowing customers to get the most out of their production environment.

#### On-Site Service

Our service and support is available to provide regular maintenance and emergency service at your facility.

#### Parts Support

We have thousands of parts in stock, ready for same day shipment including specific wear parts. Parts customer service representatives staff are ready to assist, ensuring you get the part you need - when you need it.

#### Product Repair & Refurbishment

Extend the life of your investment through factory repair and refurbishment, bringing your equipment to near-new condition.



**Tech Tip:** To extend system life, set up a regular maintenance interval for the system and monitor machine performance regularly. Learn more within the owner's manual of your machine.

### Applications

The Tangential series of granulators can be used in a wide variety of applications, due to the flexibility of chamber geometry. Typical applications include, but are not limited to, the following:

- Injection molded, blow molded, or extruded scrap
- Furniture and appliances
- Film and sheet
- Automotive moldings, ducts, and components



# T50 SERIES

## Featuring a Wide-Open Design for Ease of Maintenance & Safety



### Twinshear™ Technology

Energy efficient granulation with solid machined rotor pocket for industry leading structural integrity

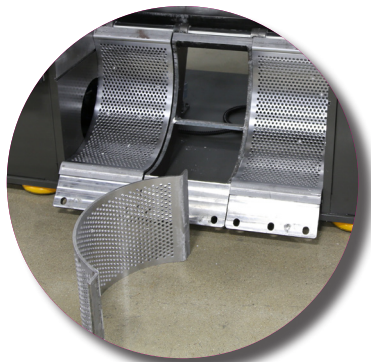
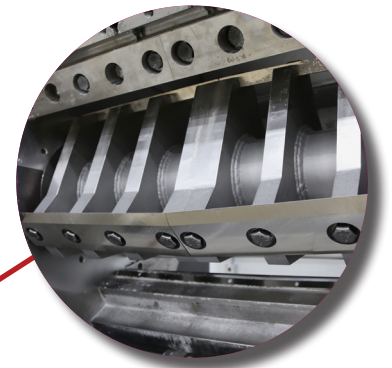

### Longer Lasting Screens

Reversible screens can be used longer, and provide increased durability



### Front Door Access with Zero Speed Solenoid

Improved safety, ensuring rotor is stopped before door can be opened, allowing wide open access to the machine

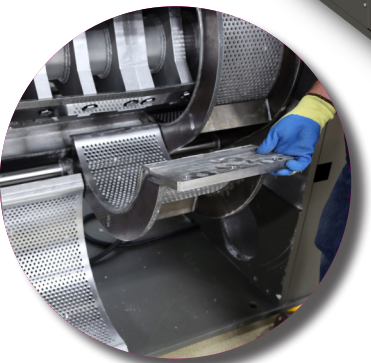

### Low Friction Joints

Improved hinge points with bearings for easy operation

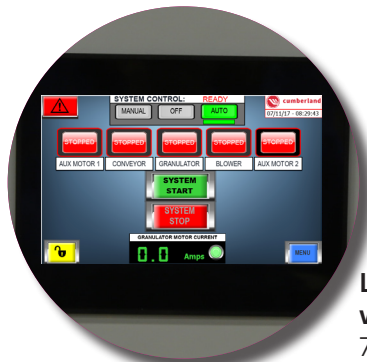

### Large Touchscreen with Intuitive Control System

7" Display with diagnostic, statistic, and maintenance data available remotely over the network





**Easier Bed Knife Maintenance**

Process and safety is improved by eliminating the need to hold the bed knife and shield at the same time

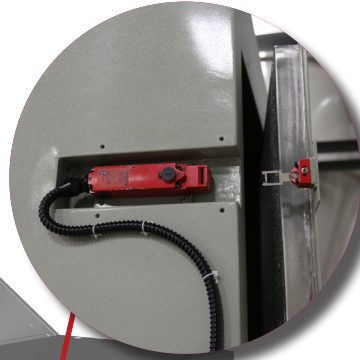

**Rear Hopper Door Access with Zero Speed Solenoid**

Improved safety by ensuring rotor is stopped before door can be opened. Improved seal to ensure regrind stays in the chamber

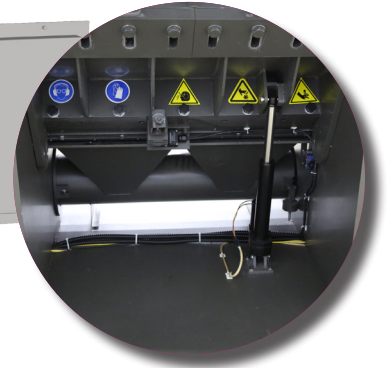

**Linear Actuator on Rear Cutting Chamber Door**

Smooth operation allows for easy bed knife access and clean out



**High Quality Regrind**

Uniform size with minimal dust

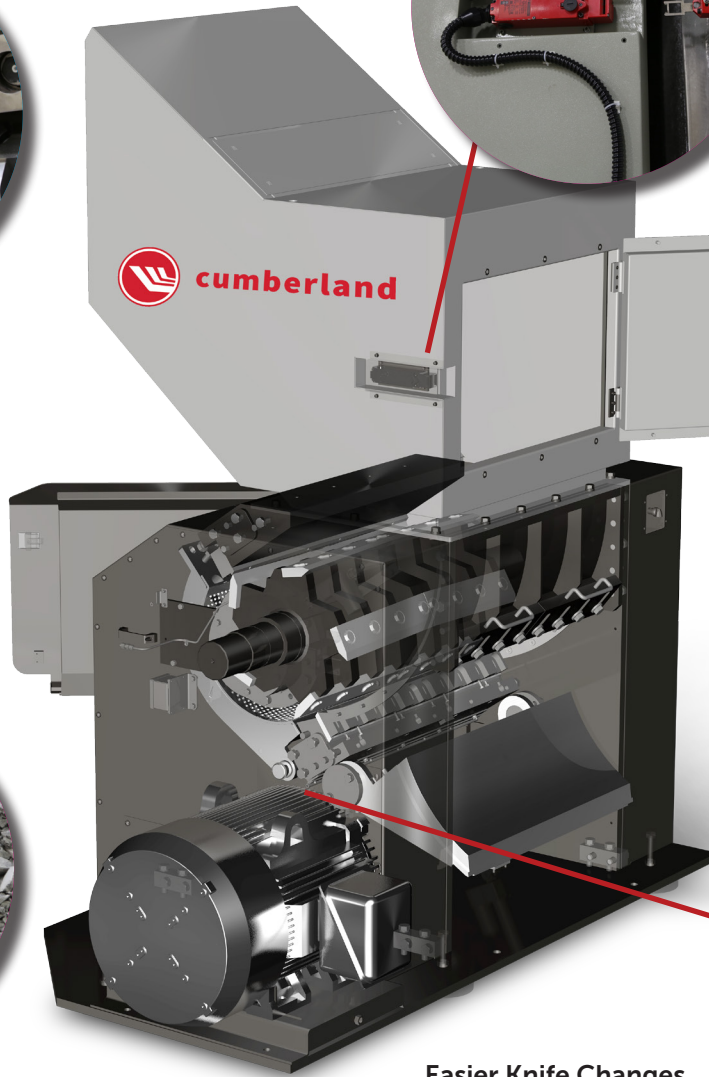

**Easier Knife Changes**

Lock the rotor in any position with a push button rotor lock

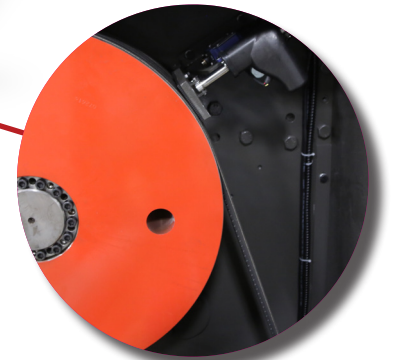

**Fast Maintenance, Quick, Easy, Convenient Access to All Areas**



Improved safety with quick access to the cutting chamber



Linear actuator grants wide open access to rear chamber

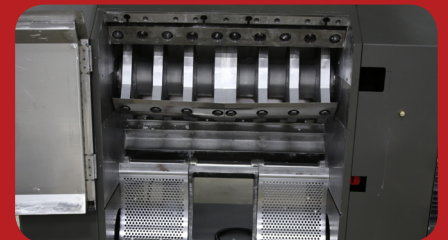

Wide open access to the front chamber for knife and screen cleaning

# T50 SERIES

## Variety of Options to Create a Machine Configured to Meet Your Needs

Determine the best chamber geometry for your application:

### Tangential

- Allows processing larger parts through a smaller machine
- Three blade rotor compliments the tangential geometry for large part ingestion
- Also available in 5 knife configurations

Examples: Large Water Bottles, Milk Jugs, HDPE Detergent Jugs, Trash Waste Bins, Laundry Baskets, Shipping Cartons

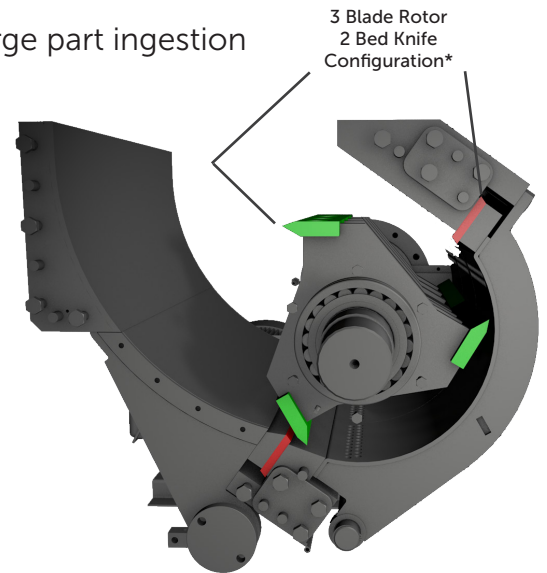

### Offset

- Limits bite size and allows for thicker walled, higher density part granulation
- Includes a third bed knife to increase cuts per revolution and maximizes throughput capabilities

Examples: Automotive Parts, PVC Fittings, Thick Plastic Parts, Film & Sheet Rolls, Plastic Appliances.

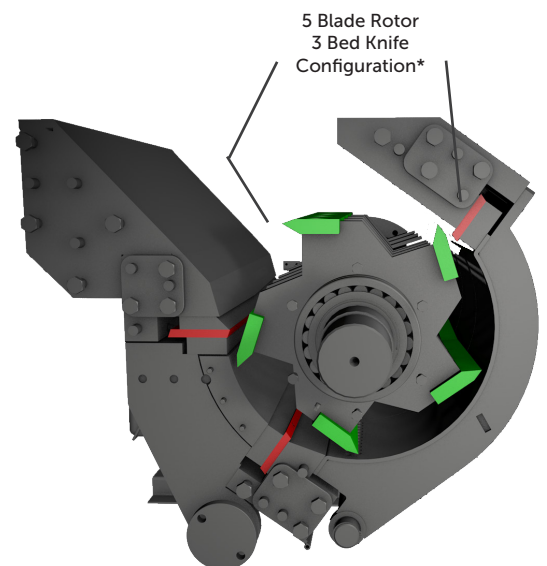

\* Images represent a typical setup, other configurations available based on your specific needs.

# Specifications

## T50 Series Granulator Models

	T5070	T5090	T50120
Throughput	1500 lbs/hr (680 kg/hr)	2000 lbs/hr (910 kg/hr)	2500 lbs/hr (1140 kg/hr)
Feed Opening	20" x 28" (50.8 cm x 71.2 cm)	20" x 36" (50.8 cm x 91.5 cm)	20" x 48" (50.8 cm x 122 cm)
Motor Options	50 HP / 75 HP / 100 HP (37 kW / 55 kW / 75 kW)	50 HP / 75 HP / 100 HP (37 kW / 55 kW / 75 kW)	75 HP / 100 HP (55 kW / 75 kW)
Rotor Type	3 Blade Open Twinshear™		
Rotor Cutting Circle Diameter	20" (508 mm)		
Rotor Speed	500 rpm		
Rotor Knives (D2)	3 Knives (6 Knives Total - 2 Per Seat) High Shear		
Infeed	Tray Feed Sound Deadened Hopper		
Screen Sizes	2 Pieces Reversible	3 Pieces Reversible	4 Pieces Reversible
Discharge Type (Right Hand)	6" (152 mm) Airveyor	8" (203 mm) Airveyor	10" (254 mm) Airveyor
Controls	480 Volt RMCP 7" HMI Color Touchscreen, Soft Start Current Monitoring (Digital Display)		
<b>Physical Characteristics (Tray Feed Hopper)</b>			
Weight	10,000 lbs (4536 kg)	12,500 lbs (5670 kg)	16,000 lbs (7257 kg)
Width	89" (226 cm)	97" (246 cm)	109" (277 cm)
Length	65" (165 cm)	65" (165 cm)	65" (165 cm)
Height	84" (213 cm)	84" (213 cm)	84" (213 cm)
<b>Optional Features</b>			
Cutting Chamber	3 Bed Knives Offset Water Cooled Abrasion Resistance		
Rotor	5 Blade Open Twinshear™ High Shear		
Infeed	Conveyor Feed Side Feed Customized		

\* Shipping weight does not include packaging materials, such as pallets, cardboard, etc.



**Tech Tip:** 12 - 24 hours after knife changes, adjust the knife gap to ensure consistent regrind quality and low energy consumption.





## Get More From Your Production Floor

Count on Cumberland to deliver a comprehensive line of size reduction systems and supporting equipment to help you drive efficiency and performance in your operation. Our technical support team is ready to evaluate your operation and ensure the right solution for all of your size reduction needs.

## Cumberland History

Building on a tradition of engineering excellence dating back to 1939, our granulators and shredders deliver efficient and reliable size reduction solutions for a wide range of industries including: plastics processing, chemical applications, and recycling operations. Cumberland was formed through a series of mergers, including Ball & Jewel (1977) and Nelmor (1978), whom today make up the Cumberland brand of size reduction equipment.

## Aftermarket Service & Support

Cumberland has a service network across the United States and in several key international locations. We are focused on having the right people and products in the right place to keep our customers running efficiently. Whether you need On-Site Service, Technical Support & Training, Parts Support or even Product Repair & Refurbishment, we have you covered. Contact our team today for all of your size reduction aftermarket needs at 262-641-8600 or [service@acscorporate.com](mailto:service@acscorporate.com).

## About ACS Group

The ACS Group designs, manufactures, markets and supports one of the most comprehensive lines of auxiliary products for the plastics processing industry. Over the years, ACS Group has grown both organically through technical innovation and through acquisition. ACS Group offers a complete product line, which includes size reduction equipment (granulators and shredders), material conveying equipment, metering and blending devices, heat exchangers (mold temperature controls units and chillers), drying systems, and hydraulic presses.



**ACS Group** | 2900 South 160<sup>th</sup> Street, New Berlin, WI 53151  
**P:** 1.262.641.8600 **E:** [info@acscorporate.com](mailto:info@acscorporate.com) **W:** [acscorporate.com](http://acscorporate.com)